

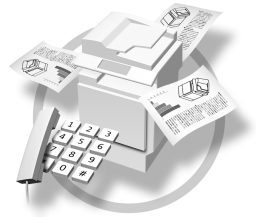

FAX Option Type 1232

Operating Instructions Facsimile Reference (option) <Basic Features>



-
- 1 Getting Started
 - 2 Faxing
 - 3 Registering
 - 4 Troubleshooting

Introduction

This manual describes detailed instructions on the operation and notes about the use of this machine. To get maximum versatility from this machine all operators are requested to read this manual carefully and follow the instructions. Please keep this manual in a handy place near the machine.

Notes

Some illustrations in this manual might be slightly different from the machine.

Certain options might not be available in some countries. For details, please contact your local dealer.

Two kinds of size notation are employed in this manual. With this machine refer to the metric version.

Important

Contents of this manual are subject to change without prior notice. In no event will the company be liable for direct, indirect, special, incidental, or consequential damages as a result of handling or operating the machine.

TABLE OF CONTENTS

How to Read This Manual	1
Symbols	1
Manuals for Facsimile Mode	3
Basic Features (this manual)	3
Advanced Features	3

1. Getting Started

Control Panel.....	5
Reading the Display.....	7
Reading the Display Panel and Using Keys.....	7
Standby Display	8
Communication Display	9

2. Faxing

Placing Originals.....	11
Placing a Single Original on the Exposure Glass.....	13
Bound original page order	13
Placing Originals in the Optional Document Feeder (ADF).....	13
Originals unsuitable for the Optional Document Feeder (ADF)	14
Setting a Scan Area	14
Original sizes difficult to detect	16
Memory Transmission.....	17
Canceling a Memory Transmission.....	20
Before the Original is Scanned	20
While the Original is Being Scanned.....	20
While the Message is Being Sent	20
Canceling a transmission using [Change/Stop TX File].....	20
Canceling a transmission using the [Clear/Stop] key.....	21
Immediate Transmission.....	22
Canceling an Immediate Transmission	24
Before You Have Pressed the Start Key.....	24
After You Have Pressed the Start Key.....	24
Scan Settings	25
Resolution	25
Original Type.....	26
Image Density (Contrast)	27
Mixing Scan Settings for a Multiple Page Original	28
Dialing.....	29
Number Keys	29
Restrictions when dialing with the number keys.....	29
Pause	30
Tone	30
Quick Dials	31
Groups	32

Reception	34
Selecting the Reception Mode	34
Manual Reception.....	34
Auto Reception	34

3. Registering

Initial Settings and Adjustments	35
Programming.....	36
Editing	37
Deleting.....	37
Quick Dial	38
Programming.....	39
Editing	41
Deleting.....	41
Groups	42
Programming.....	42
Editing	45
Deleting.....	47
Deleting a destination programmed in a Group.....	47
Deleting Groups.....	48

4. Troubleshooting

Adjusting Volume	49
When the [Facsimile] Key is Lit in Red	50
Error Messages and Their Meanings	51
Solving Problems	53
INDEX	55

How to Read This Manual

Symbols

In this manual, the following symbols are used:

WARNING:

This symbol indicates a potentially hazardous situation that might result in death or serious injury when you misuse the machine without following the instructions under this symbol. Be sure to read the instructions, all of which are included in “Safety Information” in the General Settings Guide.

CAUTION:

This symbol indicates a potentially hazardous situation that might result in minor or moderate injury or property damage that does not involve personal injury when you misuse the machine without following the instructions under this symbol. Be sure to read the instructions, all of which are included in “Safety Information” in the General Settings Guide.

* The statements above are notes for your safety.

Important

If this instruction is not followed, paper might be misfed, originals might be damaged, or data might be lost. Be sure to read this.

Preparation

This symbol indicates information or preparations required prior to operating.

Note

This symbol indicates precautions for operation, or actions to take after abnormal operation.

Limitation

This symbol indicates numerical limits, functions that cannot be used together, or conditions in which a particular function cannot be used.

Reference

This symbol indicates a reference.

[]

Keys that appear on the machine's panel display.

[]

Keys and buttons that appear on the computer's display.

[]

Keys built into the machine's control panel.

Notice

B4 JIS□□, B5 JIS□□, B6 JIS□ are referred to as B4□□, B5□□, B6□ in this manual.

Manuals for Facsimile Mode

Two Facsimile Reference manuals are provided, the Basic Features manual and the Advanced Features manual. Please refer to the manual that suits your needs.

Basic Features (this manual)

The Basic Features manual explains the most frequently used fax functions and operations.

Advanced Features

The Advanced Features manual describes more advanced functions and also explains settings for key operators.

◆ Chapter 1 Transmission Mode

Explains how to send a fax at a specific time without being by the machine and also take advantage of off-peak telephone line charges.

◆ Chapter 2 Checking and Canceling Transmission Files

Explains how to cancel a transmission and resend a message when it fails to be transmitted.

◆ Chapter 3 Communication Information

Explains how to erase a fax message programmed in memory and check the contents of any file in memory.

◆ Chapter 4 Other Transmission Features

Explains the useful transmission functions. Learn how to dial numbers easily.

◆ Chapter 5 Reception Features

Explains how to receive fax messages. You can learn the various functions for easily receiving faxes, as well as functions for accurately receiving faxes, such as printing received two page originals onto one sheet, and automatically switching between facsimile and telephone when a call comes in.

◆ Chapter 6 Simplifying the Operation

Explains how to specify a Program and use the Document Server.

◆ Chapter 7 Facsimile Features

Explains functions for printing lists and various types of reports, as well as set functions when sending and receiving faxes.

◆ Chapter 8 Key Operator Setting

Explains functions which the key operator handles. Learn how to setup the phone line type and how to store the Memory Locked ID and the Confidential ID.

❖ **Chapter 9 LAN FAX Features**

Explains how to fax directly from a computer and make necessary settings.

❖ **Chapter 10 Solving Operation Problems**

Explains what to do when toner runs out and when power is turned off or fails.

❖ **Chapter 11 Appendix**

You can check the consumables and options for facsimile functions.

1. Getting Started

Control Panel

The illustration of the control panel will differ depending on the installed optional unit. The following illustration has all the options installed.

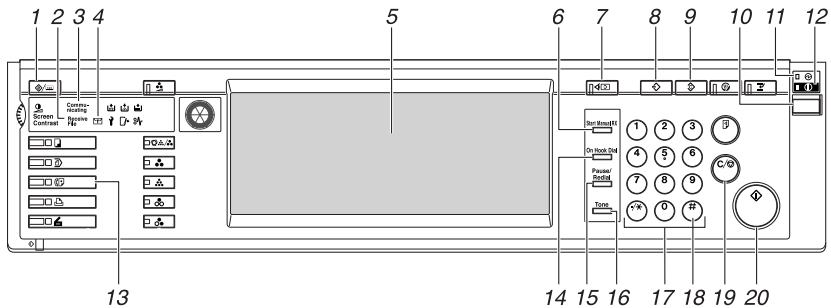

ZGRS011E

1. **【User Tools/Counter/Inquiry】** key

User Tools:

Press to enter User Tools mode. These tools allow you to customize the default settings. See p.92 "Accessing the User Tools", *Facsimile Reference (option) <Advanced Features>*.

Counter:

Displays and prints the total number of copied or printed pages.

Inquiry:

Gives your service representative information when the machine needs servicing or a new toner cartridge.

2. **Receive File Indicator**

Lights when a message other than a Confidential Reception or Memory Lock file has been received. See p.64 "Substitute Reception", *Facsimile Reference (option) <Advanced Features>*.

3. **Communicating Indicator**

Lights during transmission or reception.

4. **Confidential File Indicator**

Lights when a message has been received into memory with Confidential Reception. See p.24 "Printing a Confidential Message", *Facsimile Reference (option) <Advanced Features>*.

Blinks when a Memory Lock file has been received into memory. See p.26 "Printing a File Received with Memory Lock", *Facsimile Reference (option) <Advanced Features>*.

5. **LCD display**

This guides you through tasks and informs you of the machine status. Messages appear here.

6. **【Start Manual RX】** key

Press when using fax-on-demand services, or when Reception Mode is set to Manual Reception.

7. **【Check Modes】** key

Press this key before pressing the **【Start】** key to check the settings selected for the fax about to be sent.

8. [Program] key

Enables you to program frequently used settings and recall the programmed settings. See p.81 "Programs", *Facsimile Reference (option)* <Advanced Features> .

9. [Clear Modes] key

Press to cancel the current settings.

10. Operation Switch

Press this switch to turn the power on (the **On** indicator lights up). To turn the power off, press this switch again (the **On** indicator goes off). See p.149 "Power Failure Report", *Facsimile Reference (option)* <Advanced Features> .

11. Main Power indicator

This indicator goes on when the main power switch is turned on.

12. On indicator

This indicator goes on when the operation switch is turned on.

13. [Facsimile] key

Press to switch to the Facsimile mode.

- Lights up in yellow
Facsimile mode has been selected.
- Lights up in green
Facsimile mode has been printing.
- Lights up in red
Lights up whenever any facsimile error occurs. Press the **[Facsimile]** key to display the error message and take the appropriate action.

14. [On Hook Dial] key

Press when the manual facsimile reception is set, or using the facsimile information services.

15. [Pause/Redial] key

Pause:

Insert a pause when you are dialing or storing a fax number. A pause cannot be inserted as the first digit.

Redial:

Press to redial one of the last ten numbers. See p.33 "Redial", *Facsimile Reference (option)* <Advanced Features> .

16. [Tone] key

Press to send tonal signals down a pulse dialing line.

17. Number keys

Use to dial fax numbers or enter the number of copies.

18. [#] key (Enter key)

Registers entered numbers or settings.

19. [Clear/Stop] key

Clear:

Cancels entered numbers.

Stop:

Interrupts the current operation (transmission, scanning, copying or printing).

20. [Start] key

Press to start faxing, scanning, copying or printing.

Reading the Display

The display tells you the machine status, messages and guides you through operations.

Note

- Functions that have been selected are highlighted (for example **Auto Image Density**). Keys that you cannot select are shown with a dashed outline (for example **Dest. Management**).
- All procedures in this manual assume you are in Facsimile mode. If the machine is not in Facsimile mode, press the **[Facsimile]** key to change to Facsimile mode. You can have the machine start in Facsimile mode. See “General Features” in the General Settings Guide.
- This machine automatically returns to the standby mode if you do not use the machine for a certain period of time. You can select the period in Fax Reset Timer. See “Timer Setting” in the General Settings Guide.

Reading the Display Panel and Using Keys

The display contents will be different depending on the installed optional unit.

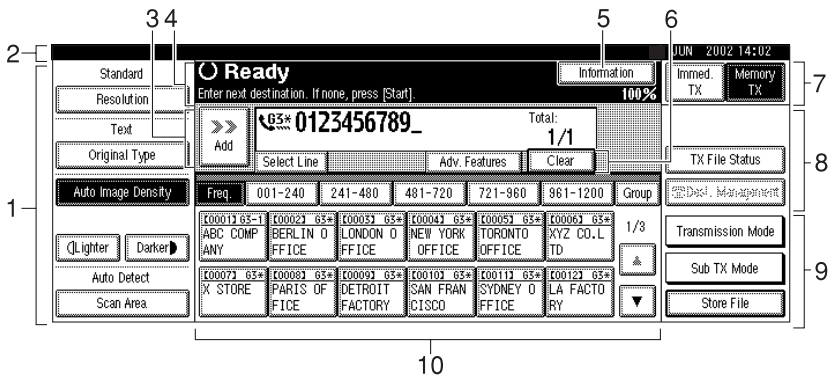

1. Displays the scanning conditions and sizes you can choose.

2. Displays the date and time, the name and facsimile number of a destination when transmitting, and the size of the original.

3. Displays the entered number of a destination. When adding destinations with the number keys, press [Add].

4. Displays messages and the machine status.

ZDP5131E

5. Press to display various information about transmission.

6. Appears when a destination is entered. Press **[Clear]** or the **[Clear/Stop]** key to erase characters or numbers one by one.

7. Switches the transmission mode between Memory Transmission and Immediate Transmission.

8. Displays Quick Operation Keys set for often used functions. **[TX status display]** and **[Dest. Management]** are preset.

9. Displays various functions for transmitting.

10. Displays the Quick Dial Table of programmed destinations.

Standby Display

While the machine is in standby mode (immediately after the **[Facsimile]** key is pressed or after the **[Clear Modes]** key is pressed), the following display is shown.

◆ Initial display

The screenshot shows the machine's standby display with the following elements:

- Ready** status indicator.
- Information** field showing 100%.
- TX File Status** buttons: **Immed. TX** and **Memory TX**.
- Dest. Management** button.
- TX File Status** button.
- Transmission Mode** button.
- Sub TX Mode** button.
- Store File** button.
- Quick Dial Table** with columns for **Freq.** and **Group**.

Freq.	001-240	241-480	481-720	721-960	961-1200	Group
000013 03-1	000023 03*	000033 03*	000043 03*	000053 03*	000063 03*	1/3
ABC COMP ANY	BERLIN OFFICE	LONDON OFFICE	NEW YORK OFFICE	TORONTO OFFICE	XYZ CO. LTD	
000073 03*	000083 03*	000093 03*	001103 03*	001113 03*	001123 03*	
TX STORE	PARIS OFFICE	DETROIT FACTORY	SAN FRAN CISCO	SYDNEY OFFICE	LA FACTORY	

📌 Note

- ❑ To return the machine to standby mode, do one of the following:
 - If you have placed the original on the optional Document Feeder (ADF) and have not pressed the **[Start]** key, remove the original.
 - If you have not placed an original, press the **[Clear Modes]** key.
 - If you are in User Tools mode, press the **[User Tools/Counter/Inquiry]** key.

Communication Display

While the machine is communicating, the status is displayed.

◆ Memory Transmission

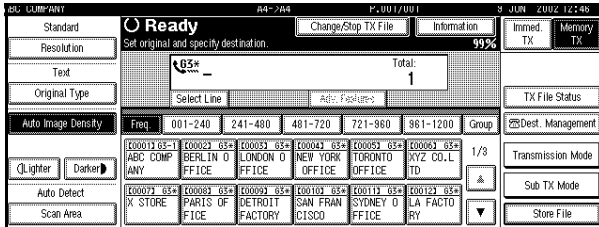

◆ Reception

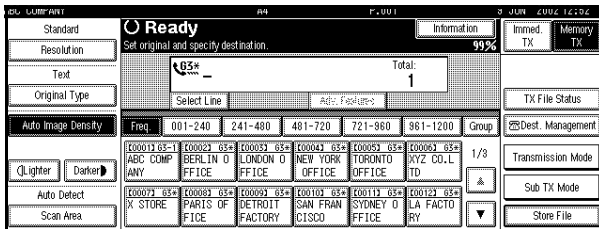

📌 Note

- ❑ Even when the machine is using memory to fax a message or receive a message, you can still scan the next original into memory. See p.59 “Dual Access”, *Facsimile Reference (option) <Advanced Features>*.
- ❑ Even when the machine is being used as a copier, printer or scanner, the sender's name or number will be displayed for received faxes.

◆ Immediate Transmission



1

Placing Originals

You can place your originals either in the optional Document Feeder (ADF) or on the exposure glass. Some types of originals are unsuitable for the optional Document Feeder (ADF) so they must be placed on the exposure glass.

Which way you place your original depends on its size and whether you are using the optional Document Feeder (ADF) or the exposure glass. See p.16 "Original sizes difficult to detect".

⚠ Limitation

- ❑ If you place A5 size documents on the exposure glass, they will not be detected. A5 size documents placed in the optional Document Feeder (ADF) are sent as A4 size.

📌 Note





- ❑ When sending a fax, the image output at the other end depends on the size and direction of paper used in the destination's terminal. If the destination does not use paper of the same size and direction as that of the original, the fax image may be reduced in size, trimmed at both edges, or divided into two or more sheets. When sending an important original, we recommend that you ask the receiver about the size and direction of the paper used in their terminal.
- ❑ When sending an original of an irregular (i.e. non-standard) size or part of a large original, you can specify the scan area precisely. See p.14 "Setting a Scan Area".

- ❑ You can scan non-standard sized documents as standard sized documents with the Irregular Scan Area function. When you turn on this function, the area scanned will be in the specified range regardless of the actual document size. A blank margin will appear or the image will be cut at the receiving end.
- ❑ If you place an A4 size original in the portrait direction, the machine rotates the image by 90 degrees before sending it. See p.59 "Transmission with Image Rotation", *Facsimile Reference (option) <Advanced Features>* .
- ❑ You can send the first pages from the exposure glass then the remaining pages from the optional Document Feeder (ADF). After you have removed the last page from the exposure glass, insert the remaining pages in the optional Document Feeder (ADF), then press the **[Start]** key.

🔍 Reference

For how to place 2-sided documents, see p.46 "2-Sided Transmission (Double-Sided Transmission)", *Facsimile Reference (option) <Advanced Features>* .

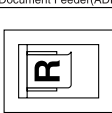
How to place A4, B4, A3, 8 1/2"×11", 11"×14", and 11"×17" size originals

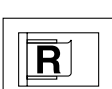



Original	Where to place originals	
	Exposure glass	Document Feeder(ADF)
*1 		
*2 		

ZFGH001E

Note

- ☐ When you place originals in the optional Document Feeder (ADF) as shown in the above illustration, the Fax Header will be printed on the received faxes at the destination as follows:
 - *1 On the top of the fax
 - *2 On the left side of the fax

How to place A4, A5 and B5 size originals

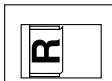
Original	Where to place originals	
	Exposure glass	Document Feeder(ADF)
*2 		
*1 		

ZFGH011E

Limitation

- ☐ A5 size documents are not detected on the exposure glass. Place A5 size documents in the optional Document Feeder (ADF).

Note

- ☐ When you place originals on the optional Document Feeder (ADF) as shown in the above illustration, the Fax Header will be printed on the received faxes at the destination as follows:
 - *1 On the top of the fax
 - *2 On the left side of the fax

Placing a Single Original on the Exposure Glass

Place originals that cannot be placed in the optional Document Feeder (ADF), such as a book, on the exposure glass one page at a time.

- 1 Lift the exposure glass cover or the optional Document Feeder (ADF) by at least 30 degrees. Place the original face down on the exposure glass. The original should be aligned to the left scale.

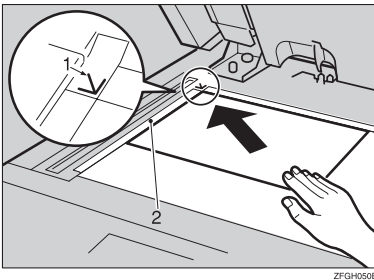

ZFGH050E

1. Reference mark

2. Scale

- 2 Close the optional Document Feeder (ADF).

Note

- When setting a bound original, the received image may contain some black areas. To reduce this effect, hold down the original to prevent its bound part from rising.

Bound original page order

When setting bound originals (books, magazines, etc.), you can choose to have either the left page or right page sent first. See p.45 "Book Fax", *Facsimile Reference (option) <Advanced Features>* .

Note

- You can choose whether the left page or right page is sent first. See p.113 "Changing the User Parameters", *Facsimile Reference (option) <Advanced Features>* (Switch14, Bit1).

Placing Originals in the Optional Document Feeder (ADF)

Use the optional Document Feeder (ADF) to scan in a stack of originals in one operation. The optional Document Feeder (ADF) can handle both single-sided and double-sided originals.

Limitation

- Place all the originals to be sent in a single stack.
- You cannot place originals in the optional Document Feeder (ADF) one page at a time or in sheaves.

Note

- The maximum document length is 1200 mm (47").
- If you send documents longer than 420 mm (17"), select Long Document mode with the User Parameters. If a jam occurs, the document might be damaged because scanning will not stop. See p.14 "Setting a Scan Area". See p.113 "Changing the User Parameters", *Facsimile Reference (option) <Advanced Features>* (Switch14, Bit1).
- Documents longer than 432 mm (17") must be sent by memory transmission (immediate transmission is not possible).
- If an original jams, press the **[Clear/Stop]** key then remove the original carefully.

- Place thin originals on the exposure glass.
- You can check information about the sizes and number of originals that can be placed in the optional Document Feeder (ADF) with "Acceptable types of Originals". See p.160 "Acceptable Types of Originals", *Facsimile Reference (option) <Advanced Features>* .

1 Adjust the document guide to match the size of your originals. Align the edges of your originals and stack them in the optional Document Feeder (ADF) face up.

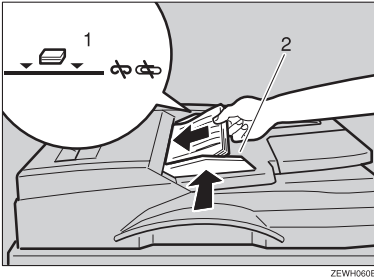

ZEWH060E

1. Limit mark

2. Document guide

Originals unsuitable for the Optional Document Feeder (ADF)

Do not place the following types of originals in the optional Document Feeder (ADF) because they may be damaged. Place them on the exposure glass instead.

- Originals containing staples or clips
- Perforated or torn originals
- Curled, folded, or creased originals
- Pasted originals
- Originals with any kind of coating, such as thermosensitive paper, art paper, aluminum foil, carbon paper, or conductive paper
- Originals with index tabs, tags, or other projecting parts
- Sticky originals, such as translucent paper
- Thin and soft originals
- Originals of inappropriate weight
- Originals in bound form, such as books
- Transparent originals, such as OHP transparencies or translucent paper

Setting a Scan Area

Normally, the area of a placed document is scanned automatically. If a scan area is specified, the document is scanned accordingly. Thus, documents can be sent without extra space or blank margins.

◆ Auto Detect







The area of a placed document is scanned automatically.

🔧 Note

- If the machine cannot detect the original size, the confirmation display is shown. Replace the original and make the copy again.

◆ Regular

The placed document is scanned according to the specified size regardless of its actual size.

The sizes that can be specified are A4 , B4 , A3 , 8 1/2"×11" , 11"×14" , and 11"×17" .

◆ Area

Enter the area to be scanned. The placed document is scanned according to the entered size regardless of its actual size. See p.99 "Programming and Changing a Scan Size", *Facsimile Reference (option) <Advanced Features>* .

- 1 Place the originals, and select any scan settings you require.

 **Note**

- When placing different size originals into the optional Document Feeder (ADF), adjust the document guide to the largest original.
- Small originals may be sent at a slight slant since they do not match the document guide.

- 2 Press [Scan Area].

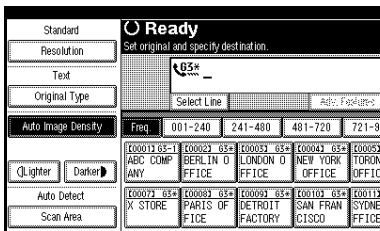

The Scan Area menu is shown.

- 3 Select the scan area.

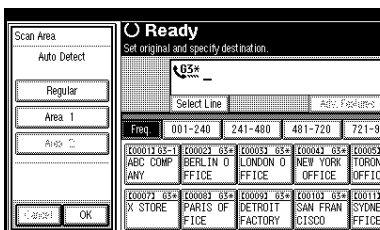

Specifying standard sizes

- 1 Press [Regular].

- 2 Press the size of the originals to be sent, and then press [OK].

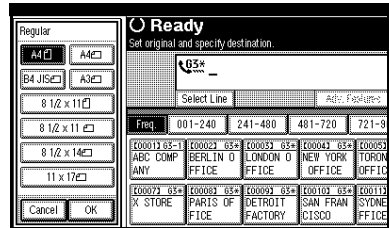

 **Note**

- To cancel the specified standard size, press [Cancel]. The display appears as in step 2.

- 3 Press [OK].

[Regular] is highlighted on the display and the size is shown above this.

Specifying programmed sizes

- 1 Press [Area 1] or [Area 2], and then press [OK].

[Area 1] or [Area 2] is highlighted on the display the scan area is shown above this.

 **Note**

- To cancel the set programmed size, press [Cancel]. The menu returns to that of step 2.

- 4 Dial a destination and press the [Start] key.









Original sizes difficult to detect

The machine finds it difficult to detect the size of the following kinds of originals. If this happens, the receiving machine may not select print paper of the correct size.







- Documents placed on the exposure glass of sizes other than those listed in the table below
- Originals with index tabs, tags, or projecting parts
- Transparent originals, such as OHP transparencies or translucent paper
- Dark originals with many characters or drawings
- Originals which partially contain solid printing
- Originals which have solid printing at their edges
- Slippery originals
- Originals in bound form of more than 10mm (0.3") thick such as books

The following paper sizes are automatically detected in Facsimile mode.

◆ Metric Version

Paper Size Where Original is placed	A3 	8 1/2"×13" (F4)	B4 	A4  	B5  	A5  
Exposure Glass	○	○	○	○	○	×
Optional Document Feeder (ADF)	○	○	○	○	○	○

◆ Inch Version

Paper Size Where Original is Placed	11"×17" 	8 1/2"×14" 	8 1/2"×11"  	5 1/2"×8 1/2"  
Exposure Glass	○	○	○	×
Optional Document Feeder (ADF)	○	○	○	○

○ - Auto detect

× - Unable to auto detect

Memory Transmission

In Memory Transmission mode, after you press the **[Start]** key, the machine does not dial the destination until all pages of your fax message have been scanned into memory (in contrast with Immediate Transmission, where the number is dialed first and pages are scanned and sent one by one).

Memory Transmission is useful because:

- You can take your original away from the machine without having to wait too long.
- While your message is being sent, other people can operate the machine.
- You can send the same message to more than one place in a single operation (Broadcasting).

Important

- If there is a power failure (main power switch is off) or the plug is pulled out for more than 1 hour, all the documents programmed in memory are deleted. As soon as the main power switch is turned on, the Power Failure Report is printed to help you identify deleted files. If you turn just the operation switch off, documents are not deleted. See p.149 "Power Failure Report", *Facsimile Reference (option) <Advanced Features>* .

Limitation

- If memory is full (0% appears on the display), Memory Transmission is disabled. Use Immediate Transmission instead.

Note

- Maximum number of destinations per Memory Transmission: 500
- Combined total number of destinations that can be programmed: 500 (2,000 with the optional Fax Function Upgrade Unit).
- The theoretical maximum number of destinations you can enter with the number keys is 100 (1,000 with the optional Fax Function Upgrade Unit), but this will depend on the amount of memory currently available. See p.29 "Restrictions when dialing with the number keys".
- The number of pages that you can store in memory depends on the original images and the scan settings. You can store up to 160 standard pages (ITU-T #1 chart, Resolution: Standard, Original Type: Text).
- The maximum total number of documents that can be programmed in memory is as follows:
 - About 1,000 pages with only the optional Expansion Memory installed
 - About 2,080 pages with both the optional Expansion Memory and Fax Function Upgrade Unit installed
- The number of programs that you can store is 400. You can store 800 programs with the optional Fax Function Upgrade Unit.

- ❑ You can set whether the machine will return to the default transmission mode (Memory Transmission or Immediate Transmission) after every transmission. You can change this so that the desired setting is maintained. See p.102 “General Settings/Adjustment”, *Facsimile Reference (option) <Advanced Features>*.

1 Make sure that Memory Transmission is selected.

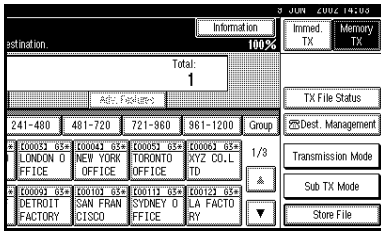

If it is not, press [Memory TX].

2 Place the original.

Note

- ❑ Note that you cannot place pages on the exposure glass after you have started using the optional Document Feeder (ADF).
- ❑ You can send the first pages from the exposure glass then the remaining pages from the optional Document Feeder (ADF). After you remove the last page from the exposure glass, you have 60 seconds to insert the remaining pages in the optional Document Feeder (ADF).
- ❑ To store multiple page originals from the exposure glass, place them page by page.
- ❑ The original can be placed in either the optional Document Feeder (ADF) or exposure glass until the [Start] key is pressed.

Reference

See p.11 “Placing Originals”.

3 Make the necessary settings you require.

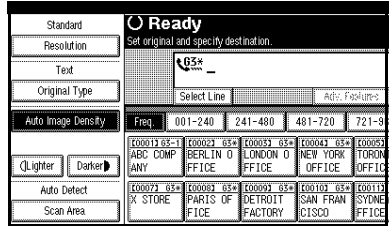

Reference

See p.25 “Scan Settings”.

4 Dial a destination.

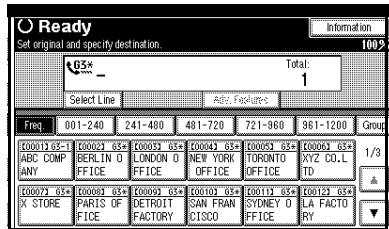

Note

- ❑ If you make a mistake, press [Clear] or the [Clear/Stop] key, and then enter the correct number.

Reference

See p.29 “Dialing”.

See p.31 “Quick Dials”.

See p.32 “Groups”.

See p.33 “Chain Dial”, *Facsimile Reference (option) <Advanced Features>*.

See p.33 “Redial”, *Facsimile Reference (option) <Advanced Features>*.

- 5** When sending the same original to several destinations (broadcasting), press **[Add]** to specify the destinations.

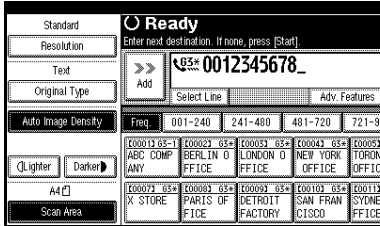

Note

- You do not have to press **[Add]** when adding a destination to the address list using Group Dial.
- If you do not want to do a broadcast transmission, proceed to step **6**.
- Repeat this step to specify a different destination.

- 6** Press the **[Start]** key.

After scanning, the machine will return to standby mode.

Sending originals from the exposure glass

- 1** Place the first page of your original on the exposure glass face down.
- 2** Dial a destination.
- 3** Make any scan settings you require.
- 4** Press the **[Start]** key.
The machine starts scanning the original.

- 5** Place the next original on the exposure glass within 60 seconds after the machine has finished scanning the first original.

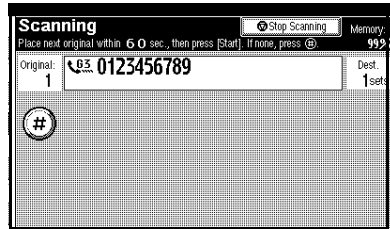

Note

- Repeat steps **3** to **5** for all originals.
- 6** Place the last original, and then press **[#]**.

Checking the transmission settings

You can check the transmission settings (e.g. destination and transmission mode) on the display.

- 1** Press the **[Check Modes]** key.
The following display appears.

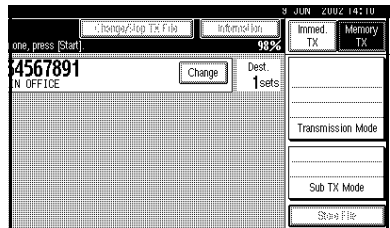

- 2** After checking the settings on the display, press the **[Check Modes]** key.
The display returns to the display shown before pressing the **[Check Modes]** key the first time.

Canceling a Memory Transmission

Before the Original is Scanned

Canceling a transmission before pressing the **[Start]** key. Use this procedure to cancel a transmission before the original has been scanned.

1 Press the **[Clear Modes]** key.

 **Note**

- When documents are placed in the optional Document Feeder (ADF), you can cancel the transmission by just removing them.

While the Original is Being Scanned

Canceling a transmission after pressing the **[Start]** key. Use this procedure to cancel a transmission after the original has been scanned.

1 Press the **[Clear/Stop]** key.

The machine will stop scanning.

 **Note**

- You can also cancel scanning by pressing **[Cancel]**.
- Originals might be scanned while you are in the process of canceling a transmission.

While the Message is Being Sent

Use this procedure to cancel a transmission after the original has been scanned.

Canceling a transmission using **[Change/Stop TX File]**

1 Press **[Change/Stop TX File]**.

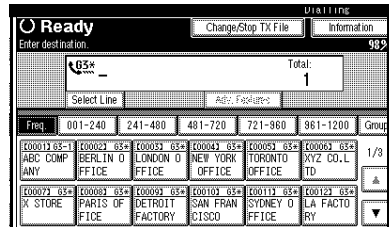

The list of programmed files being transmitted or waiting for transmission is displayed.

2 Select the file you want to cancel.

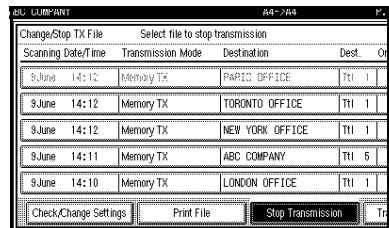

3 Press **[Stop Transmission]**.

 **Note**

- To cancel another file, repeat steps **2** and **3**.

4 Press **[Exit]**.

The machine will return to the standby mode.

Canceling a transmission using the [Clear/Stop] key

Note

- You cannot cancel the pages which already have been sent to the destination even if you cancel a transmission.
- If the transmission finishes while you are carrying out this procedure, it will not be canceled.
- If you cancel a message while it is being sent, the transmission is halted as soon as you finish this procedure. However, some pages of your message may have already been sent and may have been received at the other end.

1 Press the [Clear/Stop] key.

Note

- You can also cancel a Memory Transmission by pressing [Change/Stop TX File].

2 Select the file you want to cancel.

Scanning Date/Time	Transmission Mode	Destination	Dest.	On
8 June 14:12	Memory TX	PAPIC OFFICE	TTI	1
8 June 14:12	Memory TX	TORONTO OFFICE	TTI	1
8 June 14:12	Memory TX	NEW YORK OFFICE	TTI	1
8 June 14:11	Memory TX	ABC COMPANY	TTI	5
8 June 14:10	Memory TX	LONDON OFFICE	TTI	1

Check/Change Settings Print File **Stop Transmission** Tr

3 Press [Stop Transmission].

Note

- To cancel another file, repeat steps 2 and 3.

4 Press [Exit].

The machine will return to standby mode.

Immediate Transmission

With Immediate Transmission, when you press the **[Start]** key, the fax number is dialed immediately. The message is scanned and transmitted page by page without being stored into memory. This contrasts with Memory Transmission which scans all pages into memory before dialing the destination.

Immediate Transmission is useful if you want immediate confirmation that the message is being sent to the correct destination (just check for the other terminal's Own Name or Own Fax Number on the operation panel during transmission).

Note

- You cannot send the same message to multiple destinations (Broadcasting). The Memory Transmission allows for this purpose.
- Place the original on the exposure glass or in the optional Document Feeder (ADF). To send two or more pages from the exposure glass, set them one page at a time.
- You can scan some pages of your original from the exposure glass and the remainder from the optional Document Feeder (ADF). When you have finished scanning from the exposure glass, place the remainder of the pages in the optional Document Feeder (ADF) and press the **[Start]** key within ten seconds.

- You can set whether the machine is in Memory Transmission mode or Immediate transmission mode right after the power is turned on. See p.102 "General Settings/Adjustment", *Facsimile Reference (option)* <Advanced Features>.

1 Make sure that Immediate Transmission is selected.

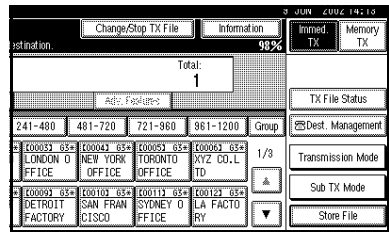

Note

- If it is not selected, press **[Immed. TX]**.

2 Place the original.

Note

- The original can be placed whenever until the **[Start]** key is pressed.
- Do not open the optional Document Feeder (ADF) while it is scanning the originals. This can cause originals to jam.

Reference

See p.11 "Placing Originals".

- 3** Select any scan settings you require.

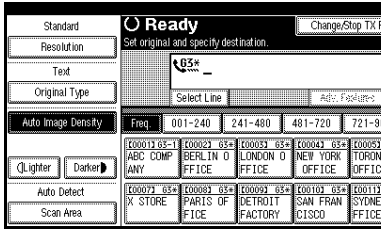

Reference

See p.25 "Scan Settings".

- 4** Dial a destination.

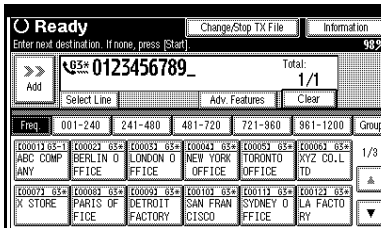

Note

- If you make a mistake, press **[Clear]** or the **[Clear/Stop]** key and enter the correct number.

Reference

See p.29 "Dialing".

See p.33 "Chain Dial", *Facsimile Reference (option)* <Advanced Features> .

See p.33 "Redial", *Facsimile Reference (option)* <Advanced Features> .

- 5** Press the **[Start]** key.

After transmission, the machine will return to standby mode.

Sending originals from the exposure glass

- 1 Place the first page face down on the exposure glass.
- 2 Dial a destination.
- 3 Make any scan settings you require.
- 4 Press the **[Start]** key.

The machine starts scanning the original.

- 5 Place the next original on the exposure glass within 10 seconds after the machine has finished scanning the first original.

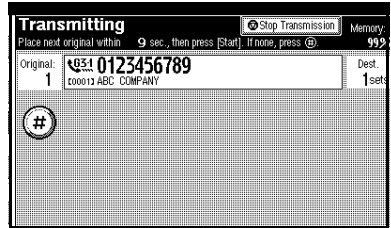

Note

- Repeat steps **3** to **5** for all originals.

- 6 Place the last original, and then press **[#]**.

2

Canceling an Immediate Transmission

Before You Have Pressed the Start Key

2

1 Press the **[Clear Modes]** key.

 **Note**

- When the original is placed in the optional Document Feeder (ADF), you can also cancel an Immediate Transmission by removing the original from the machine.

After You Have Pressed the Start Key

1 Press the **[Clear/Stop]** key, and then remove the original.

 **Note**

- You can also cancel an Immediate Transmission by pressing **[Stop Transmission]**.
- If the transmission finishes while you are carrying out this procedure, it will not be canceled.

Scan Settings

You may wish to send many different types of fax messages. Some of these may be difficult to reproduce at the other end. However, your machine has three settings that you can adjust to help you transmit your document with the best possible image quality.

◆ Resolution:

Standard, Detail, Super Fine (option)

◆ Original Type:

Text, Text/Photo, Photo

◆ Image Density (Contrast):

Auto Image Density, Manual Image Density (7 levels)

Resolution

Images and text are scanned into the machine by converting them to sequences of dots. The frequency of dots determines the quality of the image and how long it takes to transmit. Therefore, images scanned at high resolution (**Super Fine**) have high quality but transmission takes longer. Conversely, low resolution (**Standard**) scanning results in lower quality but your original is sent more quickly. Choose the setting that matches your needs based upon this trade off between speed and image clarity.

◆ Standard

Select for originals containing normal sized characters.

◆ Detail

Select for originals containing small characters or when you require greater clarity. This resolution is twice as fine as Standard.

◆ Super Fine (optional Expansion Memory required)

Select for originals with very fine details or when you require the best possible image clarity. This resolution is eight times as fine as Standard.

⚠ Limitation

- If the other party's machine does not support the resolution at which you are sending, this machine automatically switches to a resolution which is supported.
- Sending with **Super Fine** resolution requires that your machine has the optional Expansion Memory and the other party's machine has the capability to receive fax messages at **Super Fine** resolution.

📝 Note

- Note that even if the option is installed on your machine, transmission and reception may take place using **Detail** resolution if the other party's machine does not support this function.
- You can select the resolution type that is selected right after the machine is turned on or modes are cleared with [**Gen. Settings/Adjust**]. See p.102 "General Settings/Adjustment", *Facsimile Reference (option)* <Advanced Features> .
- You can set whether the machine returns to the resolution default setting after every transmission with [**Gen. Settings/Adjust**]. See p.102 "General Settings/Adjustment", *Facsimile Reference (option)* <Advanced Features> .

1 Press [Resolution].

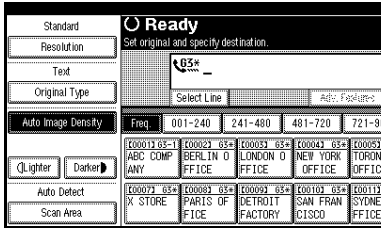

2

2 Select the resolution you require, and then press [OK].

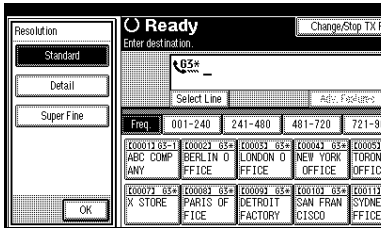

Note

- If you install the optional Expansion Memory, "Super Fine" will be displayed in the Resolution box.

Original Type

If your original contains photographs, illustrations or diagrams with complex shading patterns or grays, select the appropriate original type to optimize image clarity.

Text

Select **Text** to send an original containing a high-contrast black-and-white image. Use this setting even if your original contains text and photographs or if you only want to send clearer text.

Text/Photo

Select **Text/Photo** to send an original containing both a high-contrast black-and-white image, such as text, and a halftone image such as a photograph.

Photo

Select **Photo** to send an original containing a halftone image such as a photograph or a color original.

Note

- If you select **Text/Photo** or **Photo**, the transmission will take longer than when **Text** is selected.
- If you send a fax message with **Text/Photo** or **Photo** and the background of the received image is dirty, reduce the density setting and re-send the fax. See p.27 "Image Density (Contrast)".
- You can select the original type that is selected right after the machine is turned on or modes are cleared with [Gen. Settings/Adjust]. See p.102 "General Settings/Adjustment", *Facsimile Reference (option) <Advanced Features>*.
- You can set whether the machine returns to the original type default setting after every transmission with [Gen. Settings/Adjust]. See p.102 "General Settings/Adjustment", *Facsimile Reference (option) <Advanced Features>*.

1 Press [Original Type].

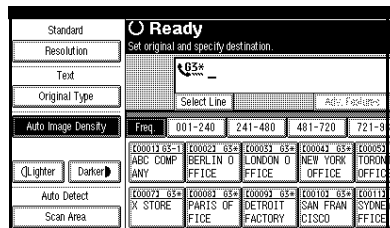

- 2** Select the original type you require, and then press [OK].

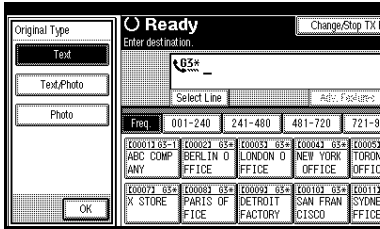

Image Density (Contrast)

The text and diagrams in your original should stand out clearly from the paper they are written on. If your original has a darker background than normal (for example, a newspaper clipping), or if the writing is faint, adjust the image density.

◆ Auto Image Density

The appropriate density setting for the original is automatically selected.

◆ Manual Image Density

Use manual image density to set image density yourself.

◆ Combined Auto and Manual Image Density

You can adjust image density for only photographs, illustrations or diagrams when the original has a dark background.

🔑 Note

- You can select the image density that is selected right after the machine is turned on or modes are cleared with [Gen. Settings/Adjust]. See p.102 “General Settings/Adjustment”, *Facsimile Reference (option)* <Advanced Features> .

- You can set whether the machine returns to the image density default setting after every transmission with [Gen. Settings/Adjust]. See p.102 “General Settings/Adjustment”, *Facsimile Reference (option)* <Advanced Features> .

1 Selecting the type of image density.

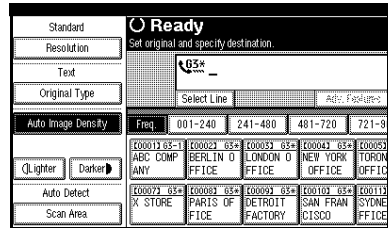

Auto Image Density

- 1** Make sure that [Auto Image Density] is selected.

🔑 Note

- If [Auto Image Density] is not selected, press [Auto Image Density].

Manual Image Density

- 1** Make sure that [Auto Image Density] is not selected. If it is selected, press [Auto Image Density] to turn it off.

🔑 Note

- If [Auto Image Density] is not selected, go to step 2.

- 2 Press [**L** Lighter] or [**D** Darker] to change the density.

Detail	Ready		Change/Stop TX F		
Resolution	Enter destination.				
Text	05#				
Original Type	Select Line		Adv: Factory		
Auto Image Density	Freq 001-240 241-480 481-720 721-9				
Lighter Darker	E00013 65-1	E00023 65*	E00033 65*	E00043 65*	E00053
Auto Detect	ABC COMP	BERLIN 0	LONDON 0	NEW YORK	TORON
Scan Area	ANY	FFICE	FFICE	OFFICE	OFFICE
	E00073 65*	E00083 65*	E00093 65*	E00103 65*	E00113
	X STORE	PARIS OF	DETROIT	SAN FRAN	SYDNE
		FFICE	FACTORY	CISCO	FFICE

Note

- You can select one of seven density levels.

Combined Auto and Manual Image Density

- 1 Make sure that [Auto Image Density] is selected.

Note

- If [Auto Image Density] is not selected, press [Auto Image Density].

- 2 Press [**L** Lighter] or [**D** Darker] to change the density.

Detail	Ready		Change/Stop TX F		
Resolution	Enter destination.				
Text	05#				
Original Type	Select Line		Adv: Factory		
Auto Image Density	Freq 001-240 241-480 481-720 721-9				
Lighter Darker	E00013 65-1	E00023 65*	E00033 65*	E00043 65*	E00053
Auto Detect	ABC COMP	BERLIN 0	LONDON 0	NEW YORK	TORON
Scan Area	ANY	FFICE	FFICE	OFFICE	OFFICE
	E00073 65*	E00083 65*	E00093 65*	E00103 65*	E00113
	X STORE	PARIS OF	DETROIT	SAN FRAN	SYDNE
		FFICE	FACTORY	CISCO	FFICE

Note

- You can select one of seven density levels.

Mixing Scan Settings for a Multiple Page Original

When sending an original consisting of several pages, you can select different image density, resolution and original type settings for each page.

Place your original, select the scan settings for the first page, dial and press the **[Start]** key as you would normally. Then follow one of the following two procedures.

Note

- While the machine is beeping, you have about 60 seconds (10 for Immediate Transmission) to select density, resolution and original type. The remaining time is shown on the display.

- 1 Check which pages you wish to scan with different settings.

- 2 Remove the previous page and place the next page.

- 3 Select the image density, resolution and original type.

Note

- Adjust settings for each page before you press the **[Start]** key.

Dialing

There are three main ways to dial a number:

- ◆ **Number Keys**
See p.29 “Number Keys”.
- ◆ **Quick Dials**
See p.31 “Quick Dials”.
- ◆ **Groups**
See p.32 “Groups”.

This section covers these function and others in more detail.

Number Keys

Enter numbers directly using the key pad on the right side of the operation panel.

Note

- Maximum length of a fax number: 254 digits.
- You can insert pauses and tones in a fax number. See p.30 “Pause”, p.30 “Tone”.
- If the optional ISDN Unit is installed, you may need to enter a sub-address and UUI. See p.39 “Sub-address”, *Facsimile Reference (option)* <Advanced Features> . See p.40 “UUI”, *Facsimile Reference (option)* <Advanced Features> .

Restrictions when dialing with the number keys

Fax numbers entered with the number keys are programmed in the internal memory (separate from memory for storing original data).

1 Enter the fax number with the number keys.

The digits appear on the display as you enter them.

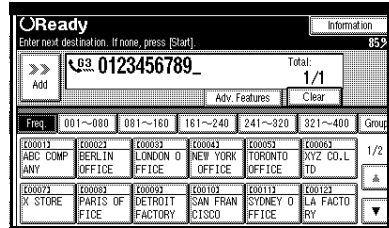

Note

- If you make a mistake, press **[Clear]** or the **[Clear/Stop]** key and enter again.
- If the optional ISDN Unit is installed, select G3 or G4 before you go to the next step. See p.43 “Changing the Line Type”, *Facsimile Reference (option)* <Advanced Features> .

Therefore, using the number keys, you cannot program more than 100 numbers in total for the following:

- Destinations specified in a Memory Transmission (including Confidential Transmission and Polling Reception)
- Transfer Stations and End Receivers specified in a Transfer Request
- Destinations and Transfer Stations specified in a Group
- Destinations specified in program registration

For example, when 90 destinations are programmed in a Group with the number keys, only 10 destinations can be dialed for Memory Transmission from the number keys.

Note

- When this machine is requested to transfer a call (i.e. become a Transfer Station), 2 fax numbers are automatically programmed. Therefore, the number of destinations that can be dialed from the number keys decreases by two whenever this machine is requested to transfer a call.
- When a total of 100 fax numbers (1,000 with the optional Fax Function Upgrade Unit) is programmed, only Immediate Transmission is allowed.
- If a memory file is awaiting transmission and the "Memory is full. Cannot scan more. Transmitting only scanned pages." message is displayed when dialing with the number keys, you cannot dial any more numbers. This is because fax numbers have been dialed with the number keys for some of the files awaiting transmission. When these files have been sent and their fax numbers are deleted from memory, additional fax numbers can be dialed.
- The display shows the percentage of free memory space for storing originals. Since fax numbers are programmed in separate memory, dialing fax numbers with the number keys does not change the percentage on the display.

Pause

Press the **[Pause/Redial]** key when dialing or storing a number to insert a pause of about two seconds.

Note

- You cannot insert a pause before the first digit of a fax number. If you press the **[Pause/Redial]** key at the first digit, a redial takes place. See p.33 "Redial", *Facsimile Reference (option) <Advanced Features>* .
- A pause is shown as a "-" on the display.
- You can insert pauses in numbers programmed in Quick Dials.

Tone

This function allows a machine connected to a pulse dialing line to send tonal signals (for example if you want to use a special service on a tone dialing line). When you press the **[Tone]** key, the machine dials the number using tonal signals.

Limitation

- You cannot place a tone before the first digit of a fax number.
- Some services may not be available when using the **[Tone]** key.

Note

- A tone is shown as a "•" on the display.

Using the [Tone] key with On Hook Dial

- ① Press the **[On Hook Dial]** key.
- ② Enter the fax number with the number keys.
- ③ Press the **[Tone]** key.
- ④ Enter the ID number with the number keys.

Sending tonal signals by ISDN (Optional ISDN unit required)

You can still send tonal signals to a G3 user even if the machine is only connected to an ISDN line.

Note

- This function can only be used for Memory or Immediate Transmission. You cannot dial through ISDN using On Hook Dial or Manual Dial.
- When G4 is selected, the display shows UUI after a tone indication “•”.
- When G3 is selected on ISDN line, you can set the indication after a tone indication “•” in the User Parameters: BP (tone) or UUI. See p.113 “Changing the User Parameters”, *Facsimile Reference (option)* <Advanced Features> (Switch11, Bit1).

Quick Dials

When you have programmed a destination's number in a Quick Dial Table, you can dial the number by just selecting the destination from the Quick Dial Table.

Additionally, you can store a name that will appear on the display whenever you press that Quick Dial.

Preparation

You must program the fax number of a destination for the Quick Dial Table prior to using Quick Dials. See p.38 “Quick Dial”.

Note

- When you press the title key above the destination keys, the destination keys programmed in that title key appear.
- A stored name can be printed out on the first page of a received fax at the other end. See p.53 “Transmission Options”, *Facsimile Reference (option)* <Advanced Features>.

Reference

See p.29 “Dialing”.

- 1** Place your original, and then select any scan settings you require.
- 2** Press the title key for the table with the desired Quick Dial key.

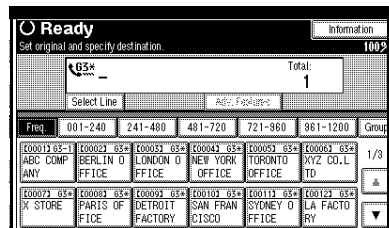

Note

- There are three types of title in the Quick Dial Table: "Title 1", "Title 2", and "Title 3"
- Use [**Dest. Management**] to switch the titles of the Quick Dial Table.

2

3 Press the Quick Dial key.

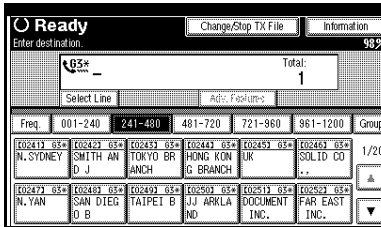

Note

- To cancel a selected destination, press that destination again.
- If you wish to dial another destination, repeat from step 2.

4 Press the [**Start**] key.

Groups

If you frequently send the same message to more than one place, program these numbers into a Group. Then you can send messages to all the destinations in that Group with just a few keystrokes. You can also program a name for the Group (for example, "Branch Offices") which will be displayed before you press the [**Start**] key.

Preparation

You need to program the Groups. See p.42 "Groups".

Limitation

- Group Dial can be used only for Memory Transmission; it cannot be used for Immediate Transmission. The machine automatically changes to Memory Transmission when you use Group Dial.

Note

- A total of 500 destinations can be programmed for Group Dial.

1 Place your original and select any scan settings you require.

2 Press [**Group**].

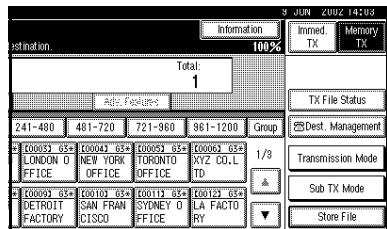

- 3** Press the **Group** key for the desired group.

The screenshot shows the 'Ready' screen with the following details:

- Header: Ready, Change/Stop TX File, Information
- Enter destination: 989
- Destination: 05* (Total: 1)
- Select Line: Adv. Features
- Frequency bands: 001-240, 241-480, 481-720, 721-960, 961-1200
- Grid:

E013	E023	E033	E043	E053	E063
OFFICE	FACTORY	USA	EU	FACTORY	BRANCHES
- Group: 1/2
- Grid:

E073	E083	E093	E103	E113	E123
SALES SECTION	DESIGN SECTION	DEVELOP SECTION	ASIA	STORE	OCEANIA

A programmed destination and the total number of destinations is displayed. Press **[▲]** and **[▼]** to see the other destinations.

The screenshot shows the 'Ready' screen with the following details:

- Header: Ready, Change/Stop TX File, Information
- Enter next destination. If none, press [Start]: 989
- Destination: 0912345678 (Total: 2/2)
- Add: 00090 DETROIT FACTORY
- Select Line: Adv. Features, Clear
- Frequency bands: 001-240, 241-480, 481-720, 721-960, 961-1200
- Grid:

E013	E023	E033	E043	E053	E063
OFFICE	FACTORY	USA	EU	FACTORY	BRANCHES
- Group: 1/2
- Grid:

E073	E083	E093	E103	E113	E123
SALES SECTION	DESIGN SECTION	DEVELOP SECTION	ASIA	STORE	OCEANIA

Note

- If the destination is not displayed, press **[▲ Prev.]** or **[▼ Next]** to find it.
- To cancel a setting, press once more the selected Quick Dial key. You can also change the settings by pressing **[Clear]** or the **[Clear / Stop]** key.
- To set more groups, repeat from step **3**.

- 4** Press the **[Start]** key.

Reception

2

Selecting the Reception Mode

There are two ways you can set up your machine to handle incoming calls:

- Manual Reception (external telephone required)
- Auto Reception

You can change the reception mode only when the standard G3 line is used.

You cannot change the reception mode when a line other than the standard G3 line (G3-2, I-G3, or G4) is used.

Manual Reception

When a telephone call comes in, the machine rings. If the call is a fax message, you must manually change to facsimile mode.

Auto Reception

When a telephone call comes in, the machine automatically receives it as a fax message. Use this setting for a dedicated fax line.

Note

- The optional external telephone is required to use this machine as a telephone.

Receiving a fax in Manual Reception mode

- ① When the machine rings, pick up the handset of the external telephone.
- ② If you hear beeps, press the **[Start]** key or the **[Start Manual RX]** key. (The **[Start]** key is available in the facsimile mode when an original is not placed only.)
- ③ Replace the handset of the external telephone. The machine will start receiving.

Limitation

- When printing the stored documents in the Document Server, the **[Start Manual RX]** key or the **[Start]** key cannot be used to switch to Fax Mode. Press the **[2]** key of the External Telephone.

3. Registering

Initial Settings and Adjustments

You can send information to the other party when transmitting or receiving a fax message. This information is shown on the display of the other machine and printed as a report. The following information can be sent.

Important

- You can confirm the programmed settings from Parameter Setting List. We recommend that you print and keep the Parameter List when you program or change settings. See p.116 "Printing the User Parameter List", *Facsimile Reference (option) <Advanced Features>*.

◆ Fax Header

The Fax Header is printed as the header of every fax you send. You should include your name in Fax Header.

You can program characters, symbols, number, and spaces.

Note

- You can program up to 32 characters in Fax Header. See p.102 "General Settings / Adjustment", *Facsimile Reference (option) <Advanced Features>*.

◆ Own Name

The Own Name is sent to the other party when you send or receive a fax. This name should include your name. The Own Name is shown on the display of the other machine and printed in a report.

You can program characters, symbols, number, and spaces.

Limitation

- Own Name works only when the other machine is the same make and has the Own Name function.

Note

- You can program up to 20 characters in Own Name.

◆ Own Fax Number (Facsimile number of sender)

The Own Fax Number of the sender is sent to the other party when sending a fax using a G3 line. The received facsimile number is shown on the display of the other machine and printed in a report. This function is available regardless of the make of the other party's machine.

Note

- You can program up to 20 characters in Own Fax Number.

◆ G4 Terminal ID

The optional ISDN Unit is required.

G4 Terminal ID is available when the machine is connected to an ISDN line. This information is printed by the other party's machine when a fax is transmitted.

You can program characters, symbols, number, and spaces.

Note

- You can program up to 22 characters that include Country Codes, Facsimile No., and Terminal Names in G4 Terminal ID.

Programming

Press the **[User Tools/Counter/Inquiry]** key (See p.5 “Control Panel”), then **[Facsimile Features]** ⇒ **[Gen. Settings/Adjust]** ⇒ **[Program Fax Information]**.

Note

- If “Program Fax Information” is not shown, press **[▲ Prev.]** or **[▼ Next]**.

1 Program the name and facsimile number.

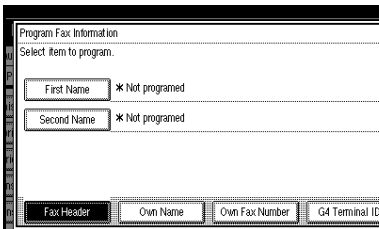

Programming a Fax Header

- 1 Press **[First Name]** or **[Second Name]**.
- 2 Enter a fax header, and then press **[OK]**.

Reference

See “Entering Text” in the General Settings Guide.

Programming an Own Name

- 1 Press **[Own Name]**.

2 Press **[Own Name]**.

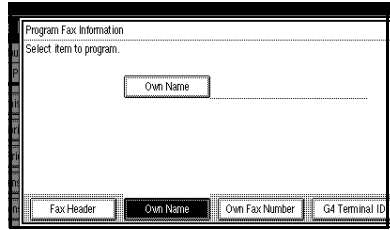

- 3 Enter an own name, and then press **[OK]**

Reference

See “Entering Text” in the General Settings Guide.

Programming an Own Fax Number

- 1 Press **[Own Fax Number]**.
- 2 Select line type to **Program**.

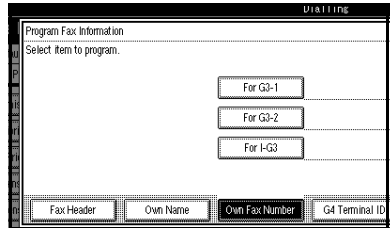

When the optional Extra G3 or G4 Interface Unit is installed, a different display appears.

- 3 Enter the own facsimile number using the number keys, and then press **[OK]**.

Note

- To enter a + sign or a space, press **[+]** or **[Space]**.
- If you make a mistake, press **[Clear]** or the **[Clear / Stop]** key, and then program the facsimile number again.

Programming G4 Terminal ID

Note

- The display appears as below when the optional ISDN Unit is installed.

1 Press [G4 Terminal ID].

2 Press [Country Code].

3 Enter the country code using the number keys, and then press [OK].

4 Press [Facsimile No.].

5 Enter the facsimile number using the number keys, and then press [OK].

6 Press [Terminal Name].

7 Enter the terminal name (abbreviated), and then press [OK].

Reference

See “Entering Text” in the General Settings Guide.

2 Press [Exit].

After programming is completed, return to the initial display.

Editing

Refer to Step 1 to 2 in “Programming” ⇒ p.36 to edit an existing fax header, own name and/or own facsimile number. Press **[Backspace]** or **[Delete All]** to delete names but press **[Clear]** or the **[Clear/Stop]** key to delete facsimile numbers.

Deleting

Refer to Step 1 to 2 in “Programming” ⇒ p.36 to delete an existing fax header, own name and/or own facsimile number. Press **[Backspace]** or **[Delete All]** to delete names but press **[Clear]** or the **[Clear/Stop]** key to delete facsimile numbers.

Quick Dial

To save time, you can program a fax number that you use often into a Quick Dial key. Then, whenever you are sending a message to that location, just press that Quick Dial key to dial.

You can also program a destination into the Quick Dial Table using **[Prog./Change/Delete]** in Facsimile Features menu. See p.94 “Program/Change/Delete Menu”, *Facsimile Reference (option) <Advanced Features>* .

Important

- We recommend that you print and keep the Quick Dial list when you program or change fax numbers. See p.101 “Reports/Lists”, *Facsimile Reference (option) <Advanced Features>* .

You can program the following items in each key:

◆ Destination Fax Number (up to 254 digits)

You can select a line type for each destination when the optional ISDN Unit or the optional Extra G3 Interface Unit is installed. Settings can also be made for SUB, SID, SEP, PWD (up to 20 characters), sub-address (optional ISDN Unit is required), UUI, pause, and tonal signals. See p.30 “Tone”. See p.35 “Advanced Features”, *Facsimile Reference (option) <Advanced Features>* .

◆ Destination Name (up to 20 characters)

You should enter the destination name when programming Quick Dials.

◆ Key Display

You can program the Key Display shown on the display (up to 16 characters). The Group name (up to 16 characters of the Group name) will be programmed as the Key Display automatically if you do not program a Key Display.

◆ Select Title

You can select a title for programmed destinations. If no specific title is selected, only “Quick Dial List” will be shown.

◆ Fax Header (which Fax Header is printed on faxes sent to this number)

See p.53 “Transmission Options”, *Facsimile Reference (option) <Advanced Features>* .

◆ Label Insertion (whether to print the destination name on faxes sent to this number)

You can program your own messages to be used as standard messages. See p.96 “Programming and Changing Standard Messages”, *Facsimile Reference (option) <Advanced Features>* .

◆ International TX Mode

When setting the International Transmission Mode to “ON”, the machine transmits reliably by lowering the transmission speed. However, the communication time will become longer.

Programming

If a destination is programmed in the Quick Dial Table, you can just press that Quick Dial key to dial.

Note

- Up to 400 destinations can be programmed. You can program up to 1,200 destinations when Fax Function Upgrade Unit is installed.
- The maximum number of digits for a fax number may be less than 254 due to the settings for SUB, SID, SEP, PWD, Space and Sub-address.

Reference

See p.94 "Program/Change/Delete Menu", *Facsimile Reference (option)* <Advanced Features>.

Press **[Dest. Management]** ⇒ **[Program/Change/Delete Quick Dial]**.

- 1** Select the Quick Dial key you want to program.

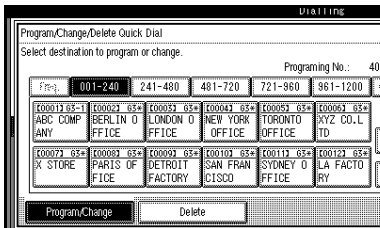

Note

- If the key has been programmed already, the contents are shown.
- Press **[Change Title]** to display another title.

- 2** Enter the receiver's name, and then press **[OK]**.

The name has been programmed.

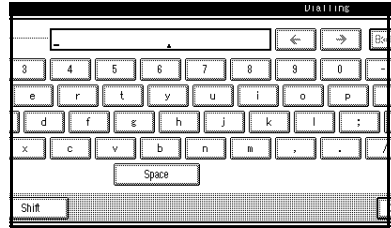

Note

- You should program the name of the receiver.

- 3** Enter the facsimile numbers you want to program with the number keys or software keys.

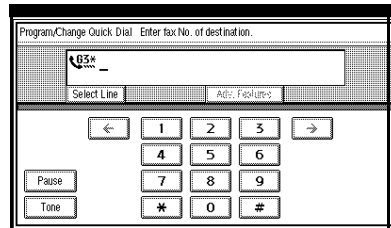

Note

- You should program a facsimile number.
- Press the **[Pause/Redial]** key for "-" when you are entering the facsimile numbers with the number keys.
- If you make a mistake, press **[Clear]** or the **[Clear/Stop]** key and start again.

- Press **[Adv. Features]** to edit SUB, SID, SEP, PWD, sub-address or UUI. See p.35 “Advanced Features”, *Facsimile Reference (option)* <Advanced Features> .
- You can select a line type for each destination when the optional ISDN Unit or the optional Extra G3 Interface Unit is installed. Press **[Select Line]** to select a line type. See p.43 “Changing the Line Type”, *Facsimile Reference (option)* <Advanced Features> .

4 When programming each item, select its key.

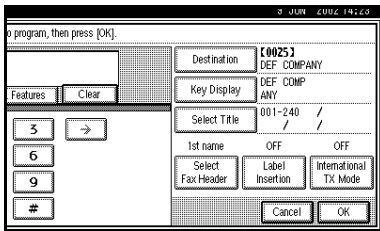

Programming/Changing Key Display

- 1** Press **[Key Display]**.
- 2** Enter a Key Display, and then press **[OK]**.

The Key Display which you programmed is shown.

Reference

See “Entering Text” in the General Settings Guide.

Selecting a title

- 1** Press **[Select Title]**.

- 2** Select the title you want to program, and then press **[OK]**.

Note

- You can program the same destination in **[Title 1]** , **[Title 2]** and **[Title 3]**.
- When **[Freq.]** is selected for one title, **[Freq.]** is selected for all titles. See p.95 “Programming Title of the Quick Dial Table”, *Facsimile Reference (option)* <Advanced Features> .

Selecting a Fax Header

- 1** Press **[Select Fax Header]**.
- 2** Select **[1st Name]** or **[2nd Name]** , and then press **[OK]**.

Programming Label Insertion

- 1** Press **[Label Insertion]**.
- 2** Select **[ON]** or **[OFF]**.

Note

- If you select **[OFF]** or if you want to insert only the receiver name, go to step **5**.

- 3** Press **[Change]** at the right side of the second or third line.
- 4** Select the standard message to be stamped at the second or third line, and then press **[OK]**.
- 5** Press **[OK]**.

Programming the International Transmission Mode

- 1** Press **[International TX Mode]**.
- 2** Select **[ON]** or **[OFF]**, and then press **[OK]**.

5 Press [OK]. **Note**

- If you press [Cancel], no changes are made. The display appears as in step 1.

6 Press [Exit] twice.

The machine will return to standby mode.

Editing

Refer to Step 1 to 6 in “Programming” ⇒ p.39 to display each programming display, and reprogram.

Press [Backspace] or [Delete All] to delete existing names but press [Clear] or the [Clear/Stop] key to delete facsimile numbers.

 **Note**

- You cannot change destinations for the Quick Dial which is being used for a Memory Transmission on standby.

Deleting

This procedure describes how to find a programmed Quick Dial and delete it.

 **Note**

- You cannot delete destinations for the Quick Dial which is being used for a Memory Transmission on standby.

Press [Dest. Management] ⇒ [Program/Change/Delete Quick Dial].

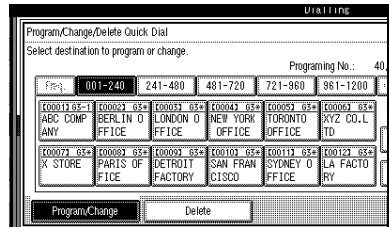
1 Press [Delete].**2** Select a Quick Dial key to be deleted.

The information for the Quick Dial key is shown.

 **Note**

- Press [Change Title] to display another title.

3 Press [Delete].

The destination has been deleted.

 **Note**

- If you press [Do not Delete], the destination is not deleted. The display appears as in step 2.

4 Press [Exit] twice.

The machine will return to standby mode.

Groups

If you send the same message to several destinations at the same time on a regular basis, program these destination numbers as a Group. This allows you to dial these destinations with a single key press.

You can program the group destination using [**Prog./Change/Delete**] in Facsimile Features menu.

3

Important

- It is recommended that you print and keep the Group Dial list when you program or change destinations. See p.101 "Reports/Lists", *Facsimile Reference (option) <Advanced Features>*.

You can program the following items in a Group:

- ❖ **Destination fax numbers (up to 500 numbers for each group or 2,200 numbers with optional Fax Function Upgrade Unit, up to 254 digits for each number)**
- ❖ **Group name (up to 20 characters)**
You should program the Group name.
- ❖ **Key Display**
You can program the Key Display shown on the display (up to 16 characters). The Group name (up to 16 characters of the group name) will be programmed as the Key Display automatically if you do not program a Key Display.

You can edit destinations which are programmed in a Group.

Programming

Preparation

All destinations to be programmed should be selected using the Quick Dial table or entered using the number keys. You can use a combination of the Quick Dial table and number keys.

Note

- The maximum number of groups that can be programmed is 64.
- The maximum number of destinations that can be programmed in one group is 500. (400 with the Quick Dial Table and 100 with the number keys)
- The combined maximum number of destinations that can be programmed in all groups is 500 (400 with the Quick Dial Table and 100 with the number keys). When the optional Fax Function Upgrade Unit is installed, it is 2,200 (1,200 with the Quick Dial Table and 1,000 with the number keys).
- The programmed number can be counted as 1, when the same destination is specified in various groups. For example, if the same destination is found in one group of 500 programmed destinations, it is possible to register it other groups. If programming 200 destinations in one group, when programming completely different destinations, number of destinations that can be programmed in the remaining groups is 300. The procedure is also similar when the optional Fax Function Upgrade Unit is installed.

□ How to count numbers

Group 1	Group 2	Total Numbers
Quick Dial [0001]	Quick Dial [0001]	8 numbers
Quick Dial [0003]		
Quick Dial [0005]	Quick Dial [0005]	
Quick Dial [0010]		
Quick Dial [0015]	Quick Dial [0015]	
Quick Dial [0020]	Quick Dial [0020]	
number key 0312345678	number key 0312345678	
number key 0451119999	number key 0451119999	

Press **[Dest. Management]** ⇒ **[Program/Change/Delete Group]**.

1 Select the Group key you want to program.

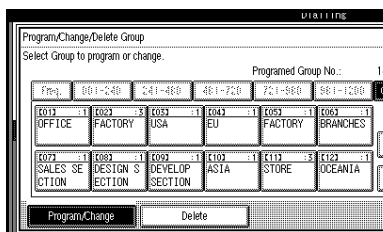

Note

- If the key has been programmed already, the contents are shown.

2 Enter the name of the group, and then press **[OK]**.

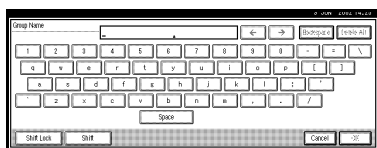

Note

- You should program the Group name.

Reference

See “Entering Text” in the General Settings Guide.

3 Specify the destinations to be programmed in the Group.

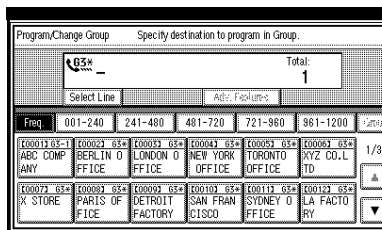

Note

- You should program facsimile numbers using the number keys or Quick Dial Table.
- Press the **[Pause/Redial]** key for “-” when you are entering the facsimile numbers with the number keys.
- If you make a mistake, press **[Clear]** or the **[Clear/Stop]** key and enter again.
- Press **[Change Title]** to display another title.
- When you specify multiple destinations using the number keys, press **[Add]**.
- When you add the destination using the number keys, press **[Adv. Features]** to program SUB, SID, SEP, PWD, sub-address or UUI. See p.35 “Advanced Features”, *Facsimile Reference (option)* <Advanced Features> .
- Press **[Dest. List]** to confirm the destinations programmed in the Group.

4 Press [OK].

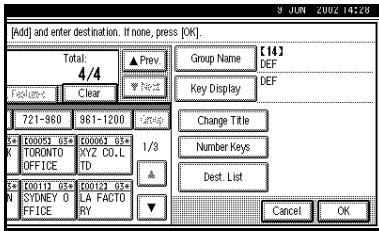

Note

- If you press [Cancel], the Group is not programmed. The display appears as in step 1.

5 Press [Exit] twice.

The machine will return to standby mode.

Programming the Group as a Transfer Station of a multi-step transfer

A group can be programmed as a Transfer Station. You should program the receiving stations when you program the Group as a Transfer Station.

For more information, contact your service representative.

Note

- If you want to program a group which has been programmed as a Transfer Station as a normal group, delete the group and program again.
- Only one destination can be programmed as a Transfer Station in a group.

- Before you program the group as a Transfer Station, you must program the Polling ID and your own fax number. See p.131 "Transfer Report", *Facsimile Reference (option) <Advanced Features>*, and p.133 "Programming a Polling ID", *Facsimile Reference (option) <Advanced Features>*.

- 1 Follow steps 1 to 3 in "Programming".
- 2 Press [Adv. Features].
- 3 Press [Transfer Req.].
- 4 Press [Receiving Station].
- 5 Specify the receiving station.

Note

- When you specify the receiving station with Quick Dial, press [Quick Dial] and enter the Group Dial number using the number keys.
- When you specify the receiving station with Group Dial, press [Group Dial] and enter the Group Dial number using the number keys.

- 6 After specifying all of the receiving stations, press [OK].
- 7 Press [OK].
- 8 Press [Exit].

Reference

See p.37 "Transfer Request", *Facsimile Reference (option) <Advanced Features>*.

See p.67 "Transfer Station", *Facsimile Reference (option) <Advanced Features>*.

Editing

Use this procedure to change the Groups already programmed.

Note

- You cannot change destinations for the group which is being used for a Memory Transmission on standby.

Press **[Dest. Management]** ⇒ **[Program/Change/Delete Group]**.

- Select the key for the group you want to change.

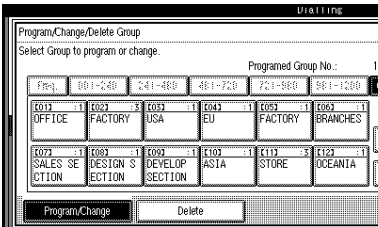

- Change the contents of the group.

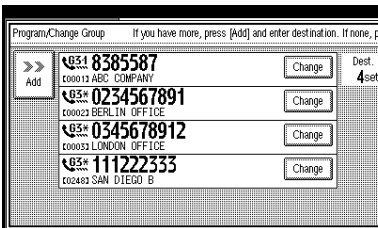

Editing a Group Name

- Press **[Group Name]**.

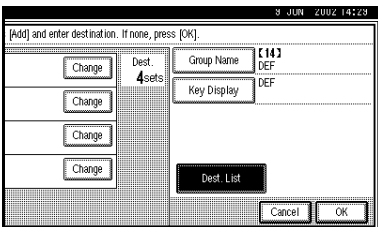

- Press **[Backspace]** or **[Delete All]**, reenter the Group name, and then press **[OK]**.

Reference

See “Entering Text” in the General Settings Guide.

The display appears as in step 2.

Editing Key Display

- Press **[Key Display]**.
- Press **[Backspace]** or **[Delete All]**, reenter the Key Display, and then press **[OK]**.

Reference

See “Entering Text” in the General Settings Guide.

The display appears as in step 2.

Editing a destination programmed in a Group

- Press **[Change]** for the destination you want to edit.

The name of the destination is displayed under the fax number if the destination is programmed with the Quick Dial Table.

- Edit the destination using the number keys or destination key.

Note

- If the destination is programmed with the number keys, press **[Clear]** or the **[Clear/Stop]** key and enter the fax number of the destination.

- ❑ If the destination is programmed with the Quick Dial Table, press **[Clear]** or the **[Clear/Stop]** key to cancel programming, and then program with the destination key again. You can cancel programming also by pressing the destination key.
- ❑ Press **[Adv. Features]** to edit SUB, SID, SEP, PWD, sub-address or UUI. See p.35 “Advanced Features”, *Facsimile Reference (option)* <Advanced Features> .
- ❑ You can select a line type for each destination when the optional ISDN Unit or the optional Extra G3 Interface Unit is installed. Press **[Select Line]** to select a line type. p.43 “Changing the Line Type”, *Facsimile Reference (option)* <Advanced Features> .
- ❑ To edit another destination, press **[Dest. List]** and proceed from step 1.

Adding destinations

- 1 Press **[Add]**.
- 2 Add the destination using the number keys or a Quick Dial key.

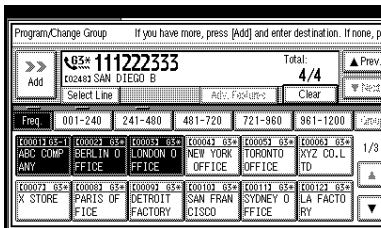

Note

- ❑ To add another destination, press **[Dest. List]** and proceed from step 1.
- ❑ You also can cancel programming by pressing the Quick Dial key of the destination to be added.
- ❑ When you add the destination using the number keys, press **[Adv. Features]** to program SUB, SID, SEP, PWD, sub-address or UUI. See p.35 “Advanced Features”, *Facsimile Reference (option)* <Advanced Features> .
- ❑ You can select a line type for each destination when the optional ISDN Unit or the optional Extra G3 Interface Unit is installed. Press **[Select Line]** to select a line type. See p.43 “Changing the Line Type”, *Facsimile Reference (option)* <Advanced Features> .

3 Press **[OK]**.

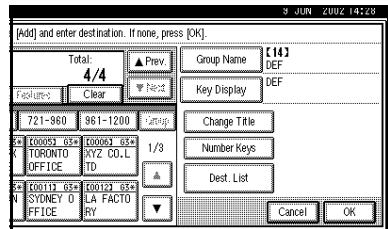

If you press **[Cancel]**, the group is not changed. The display appears as in step 1.

4 Press **[Exit]** twice.

The machine will return to standby mode.

Deleting

Note

- You cannot delete destinations for the group which is being used for a Memory Transmission on Stand-by.

Deleting a destination programmed in a Group

Press **[Dest. Management]** ⇒ **[Program/Change/Delete Group]**.

- Select the Group key which contains the destination you want to delete.

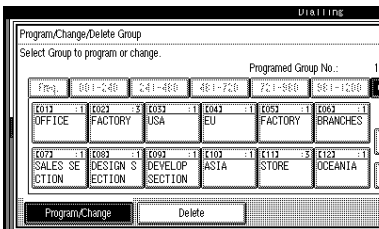

- Press **[Change]** for the destination you want to delete.

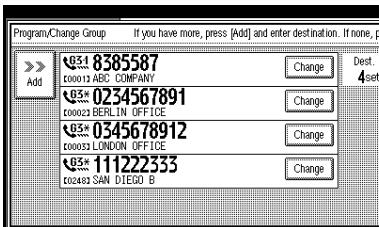

- Press **[Clear]** or the **[Clear/Stop]** key to delete the facsimile number.

If you programmed the destination with the number keys, the number will clear one digit at a time. If you programmed it with the Quick Dial Table, the number will clear all at once.

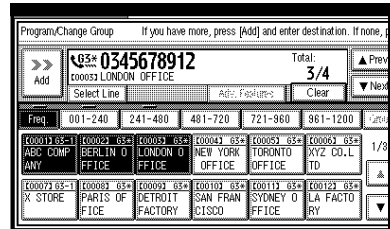

Note

- You can also delete the destination programmed with the Quick Dial Table by highlighting the destination key.

The programmed group is shown on the display.

- Press **[OK]**.

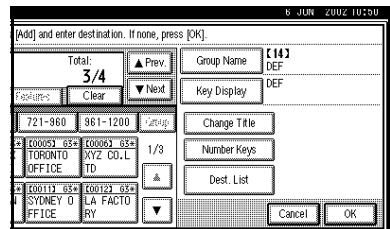

Note

- If you press **[Cancel]**, the destination is not changed. The display appears as in step 1.

- Press **[Exit]** twice.

The machine will return to standby mode.

Deleting Groups

Press **[Dest. Management]** ⇒ **[Program/Change/Delete Group]**.

1 Press **[Delete]**.

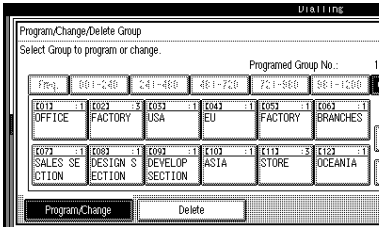

2 Select the key for the group you want to delete.

Note

- If the Group key has been programmed, the group name or Key Display is shown.

3 Press **[Delete]**.

The Group is deleted.

Note

- If you press **[Do not Delete]**, the display appears as in step **2**.

4 Press **[Exit]** twice.

The machine will return to standby mode.

4. Troubleshooting

Adjusting Volume

You can change the volume of the following sounds the machine makes.

❖ On Hook Mode

Sounds when the **[On Hook Dial]** key is pressed.

❖ At Transmission

Sounds when the machine sends a message.

❖ At Reception

Sounds when the machine receives a message.

❖ At Dialing

Sounds after pressing the **[Start]** key until the line connects to the destination.

❖ At Printing

Sounds when a received message has been printed. See p.70 "Print Completion Beep", *Facsimile Reference (option)* <Advanced Features> .

📍 Limitation

- Adjusting Volume is not available with the optional G4 line or the optional Extra G3 line.

📝 Note

- You can adjust the On Hook volume when you press the **[On Hook Dial]** key. See p.41 "On Hook Dial", *Facsimile Reference (option)* <Advanced Features> .

Press the **[User Tools/Counter/Inquiry]** key (See p.5 "Control Panel"), then **[Facsimile Features]** ⇒ **[Gen. Settings/Adjust]** ⇒ **[Adjust Sound Volume]**.

- 1** Press **[Lower]** or **[Louder]** for each item.

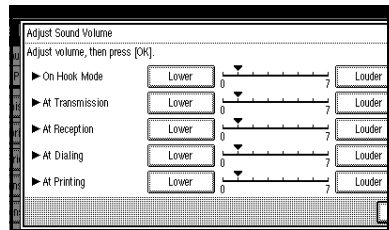

📝 Note

- You can hear the actual volume by pressing **[Check]**.

- 2** Press **[OK]**.

After adjusting is completed, return to the initial display.

📝 Note

- If you press **[Cancel]**, the volume setting is canceled.



When the **[Facsimile]** Key is Lit in Red

If this key is lit, refer to the table below and take the appropriate action.

Problem	Solution
Paper has run out.	Add paper. See "Loading Paper" in the General Settings Guide.  Note <input type="checkbox"/> When the [Facsimile] key is lit in red even papers are loaded, [Thick paper] or [OHP] might be selected for paper type for the tray. If [Thick paper] or [OHP] is set for the tray, papers in the tray will not be used for facsimile function such as printing received documents, lists or reports. Confirm the paper type setting in System Settings. See "Tray Paper Settings" in the General Settings Guide.
The paper output tray is full.	Remove the paper from the tray.
The machine is in RDS (Remote Diagnostic System) mode.	Wait with the main power switch on. The machine will enter the standby mode after it exits from the RDS mode.
A facsimile error has occurred.	The facsimile has a problem. Contact a service representative. The copier will still function normally.

Error Messages and Their Meanings

If there is an error, one of the following messages may appear on the display. It might just flash briefly, so if you are watching for errors, stay by the machine and check the display.

Message	Problem and Solution
Put original back, check it and press [Start].	Original jammed during Memory Transmission. Place originals that have not been scanned again.
Error occurred, and transmission was canceled.	A document jam occurred during Immediate Transmission. Press [OK] , and then re-send the page which has not been sent.
	<p>An error occurred during Immediate Transmission. Press [OK], and then re-send the original.</p> <p> Note</p> <p><input type="checkbox"/> There may be a problem with the machine or the telephone line (for example noise or cross talk). If the error re-occurs frequently, contact your service representative.</p>
Cannot detect original size. Place original again, then press [Start].	The machine failed to detect the size of the original. Place originals again, and then press the [Start] key.
<p> Call Service</p> <p>Functional problems with facsimile. Please call service.</p>	There is a problem with the fax function. Record the code number shown in the display and contact your service representative. The copier function will still work normally.
Memory is full. Cannot scan more. Transmitting only scanned pages.	If you press [OK] , the machine returns to the standby mode and starts transmitting pages which have been scanned.
Following output tray is full. Remove paper.	The paper output tray is full. Remove paper from the tray shown in the display.
Cannot scan to send fax message as scanner is in use for other function.	<p>The Copy or Document Server function is in use. To cancel the job in process, do the following, and then try faxing again.</p> <p>Press [Exit], and then press the [Copy] or [Document Server] key. Next press the [Clear/Stop] key. When the message “[Stop] key was pressed. Stop copying?” or “[Stop] key was pressed. Stop storing?” appears, press [Stop].</p>

 **Out of paper display message**



If the paper tray runs out of paper, you can have a message “No paper. Load it, then press [Exit].” appear on the display asking you to add more paper.

 **Note**

- You can turn this function on or off with the User Parameters. See p.113 “Changing the User Parameters”, *Facsimile Reference (option) <Advanced Features>* (Switch05, Bit7).
 - If there is paper left in the other paper trays, you can receive messages as usual even if a message appears on the display.
- 

Solving Problems

This table lists some common problems and their solutions.

Problem	Solution	Refer to
Image background appears dirty when received at the other end.	Adjust the scan density.	See p.27 "Image Density (Contrast)".
Printed or sent image contains spots.	The optional Document Feeder (ADF) or exposure glass is dirty. Clean them. Make sure that ink or correction fluid is dry before placing the original.	See "Maintaining Your Machine" in the General Settings Guide.
Received image is too light.	Request the sender to increase the image density.	---
	When using moist, rough or processed paper, the printed image may be partly invisible. Only use recommended paper.	See "Copy Paper" in the General Settings Guide.
	When  appears on the display, toner is beginning to run out. Replace the toner cartridge soon.	See "  Adding Toner" in the General Settings Guide.
Message appears blank at the other end.	The original was placed upside down. Place it properly.	See p.11 "Placing Originals".
You want to cancel a Memory Transmission.	If the original is being scanned, press [Cancel] or the [Clear/Stop] key.	See p.20 "Canceling a Memory Transmission".
	If the original is being sent or if it is in standby, press [Change/Stop TX File] or the [Clear/Stop] key.	See p.20 "Canceling a Memory Transmission". See p.13 "Checking and Canceling Transmission Files", <i>Facsimile Reference (option)</i> <Advanced Features> .
You want to cancel an Immediate Transmission.	Press the [Clear/Stop] key.	See p.24 "Canceling an Immediate Transmission".
You cannot add any destinations to a Group although the number of destinations has not reached the maximum.	100 destinations have been programmed with the number keys (1,000 with the optional Fax Function Upgrade Unit). Program more numbers with Quick Dials.	See p.29 "Dialing".

Problem	Solution	Refer to
Both transmission and receiving are impossible.	Make sure that the modular cord is correctly connected.	---
	Setting of the Terminal Adaptor is incorrect. Check the setting.	---
Transmission is possible, though receiving is impossible.	Setting of the optional Terminal Adaptor is incorrect. Check the setting.	---
Receiving is possible, though transmission is impossible.	Setting of the optional Terminal Adaptor is incorrect. Check the setting.	---

INDEX

A

- Adjusting Volume, 49
 - At Dialing*, 49
 - At Printing*, 49
 - At Reception*, 49
 - At Transmission*, 49
 - On Hook Mode*, 49
- Auto Reception, 34

B

- Broadcasting, 17

C

- Check Modes key, 5
- Clear Modes key, 6
- Clear/Stop key, 6
- Communicating Indicator, 5
- Confidential File Indicator, 5
- Control Panel, 5
- CSI→Own Fax Number, 35

D

- Detail, 25
- Dialing, 29
- Display, 7

E

- Error Messages, 51

F

- Facsimile key, 6, 50
- Fax Header, 35
 - Editing*, 37
 - Programming*, 36
- Faxing, 11

G

- G4 Terminal ID, 35
 - Editing*, 37
 - Programming*, 36
- Getting Started, 5
- Groups, 32, 42
 - Deleting*, 47
 - Dialing*, 29
 - Editing*, 45
 - Programming*, 42

I

- Image Density (Contrast), 25, 27
- Immediate Transmission, 22
 - Canceling*, 24

K

- # key (Enter key), 6

L

- LCD display, 5

M

- Main power indicator, 6
- Manual Reception, 34
- Memory Transmission, 17
 - Canceling*, 20

N

- Number keys, 6, 29

O

- On Hook Dial key, 6
- On indicator, 6
- Operation Switch, 6
- Original Type, 25, 26
- Own Fax Number, 35
 - Editing*, 37
 - Programming*, 36
- Own Name, 35
 - Editing*, 37
 - Programming*, 36

P

Pause, 30
Pause/Redial key, 6
Photo, 26
Placing Originals, 11
Program key, 6

Q

Quick Dial, 29, 31, 38
 Deleting, 41
 Dialing, 29
 Editing, 41
 Programming, 39

R

Receive File Indicator, 5
Reception, 34
 Auto Reception, 34
 Manual Reception, 34
Registering, 35
Resolution, 25
RTI→Own Name, 35

S

Scan Settings, 25
Selecting the Reception Mode, 34
Solving Problems, 53
Standard, 25
Start key, 6
Start Manual RX key, 5
Super Fine, 25

T

Text, 26
Text / Photo, 26
Tonal Signals, 31
Tone, 30
Tone key, 6
Troubleshooting, 49
TTI→Fax Header, 35

U

User Tools/Counter/Inquiry key, 5

MEMO

MEMO



Declaration of Conformity

Notice to Users in EEA Countries

This product complies with the essential requirements and provisions of Directive 1999/5/EC of the European Parliament and of the Council of 9 March 1999 on radio equipment and telecommunications terminal equipment and the mutual recognition of their conformity.

Notice to Users Accessing Analog PSTN in EEA Countries

This product is designed to be able to access analog PSTN in all EEA countries. Local PSTN compatibility is dependent on software switch settings. Please contact your service representative if relocating this product to another country. In the event of problems, please contact your service representative in the first instance.

Notice to Users Accessing ISDN in EEA Countries

This product is designed to be able to access ISDN in all EEA countries without requiring changes to software switch settings. In the event of problems, please contact your service representative in the first instance.

The CE Declaration of Conformity is available on the Internet at URL: http://www.ricoh.co.jp/fax/ce_doc/

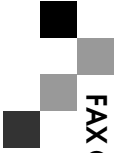

FAX Option Type 1232 Operating Instructions Facsimile Reference (option) <Basic Features>